





OPzS1200 Tubular Battery

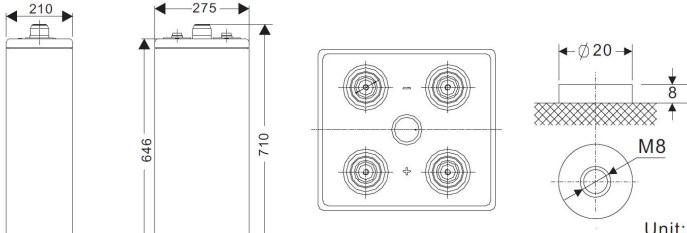

PHYSICAL SPECIFICATION

Nominal Voltage		2V	
Nominal Capacity (10HR)		1200Ah	
Dimension	Length	275±2mm	(10.83 inches)
	Width	210±2mm	(8.27 inches)
	Container Height	646±2mm	(25.43 inches)
	Total Height	701±2mm	(27.60 inches)
Weight		Approx. 92 Kg (202.8lbs)	
Standard Terminal		Bolt-and-nuts terminal Bolt Type: M8	

Unit: mm

ELECTRICAL SPECIFICATION

Characteristics			Main Advantages
Capacity	20 hour rate (74.47A to 1.80v/cell) 10 hour rate (126.8A to 1.80v/cell) 5 hour rate (216.5A to 1.75v/cell) 1hour rate (727.0A to 1.60v/cell)	1489.4Ah 1268.0Ah 1082.5Ah 727.0Ah	<ul style="list-style-type: none"> >> adopt tubular positive plate >> longest lifespan under deep discharge >> Strong temperature resistance performance >> Better charge reception capability >> 20 years design life
Operating Temp. Range	Discharge : -20℃~55℃ Charge : -10℃~45℃ Storage : -15℃~45℃		
Max. Discharge Current	6000A(5sec)		
Short Circuit Current	10000A		
Designed life	20 years (floating) at 25℃(77 °F)		
Internal Resistance	Full charged battery (25℃,77 °F) 0.21mΩ		
Constant Voltage Charge	Cycle	Initial Charging Current less than ≤300A Voltage: 2.35~2.40V at 25℃ (77 °F) Temperature Coefficient -5mV/℃	
	Standby	No limit on Initial Charging Current Voltage: 2.23V at 25℃ (77 °F) Temperature Coefficient -3mV/℃	

CONSTANT CURRENT DISCHARGE RATING A@25℃

F.V/TIME	30min	1h	2h	3h	4h	5h	8h	10h	24h
1.60V	1011	692	431	311	248	214	153.0	127.3	56.64
1.65V	977	676	423	306	246	211	151.9	126.6	56.60
1.70V	937	656	413	302	242	208	150.1	126.0	56.04
1.75V	902	636	402	295	237	205	147.4	124.2	55.08
1.80V	825	606	387	289	233	200	143.6	120.4	53.76
1.85V	732	563	366	279	226	194	139.6	118.8	52.08

CONSTANT POWER DISCHARGE RATING WATT PER CELL@25℃

F.V/TIME	30min	1h	2h	3h	4h	5h	8h	10h	24h
1.60V	1843	1276	797	576	460	396	284.5	236.6	105.72
1.65V	1799	1248	780	568	455	392	282.4	235.7	105.48
1.70V	1728	1212	763	560	450	386	278.6	234.4	104.28
1.75V	1668	1183	748	548	443	382	274.9	232.2	103.44
1.80V	1540	1141	730	545	440	379	272.8	228.1	102.12
1.85V	1392	1068	698	534	432	372	267.8	227.0	100.92

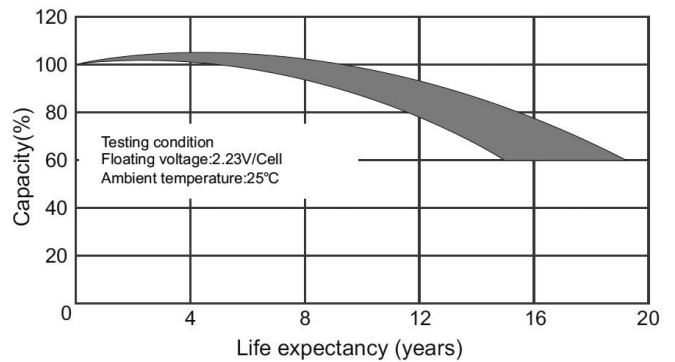
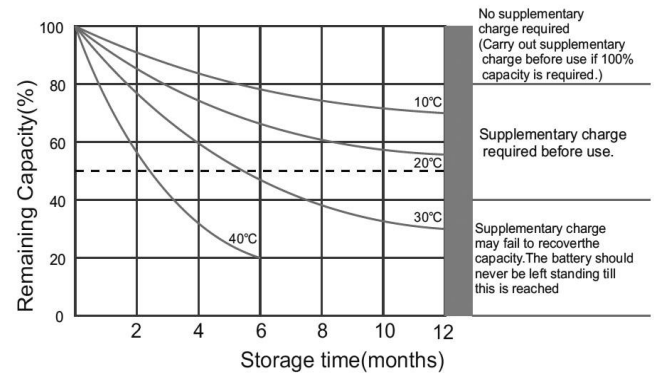
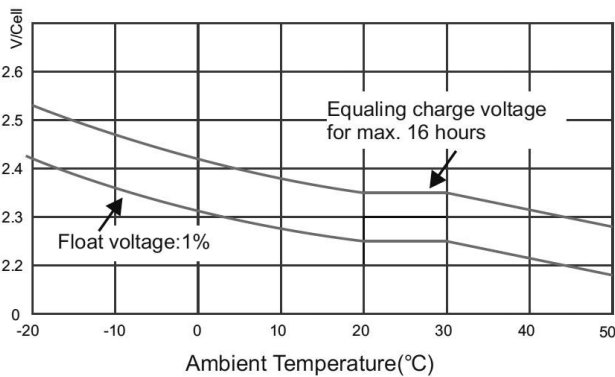
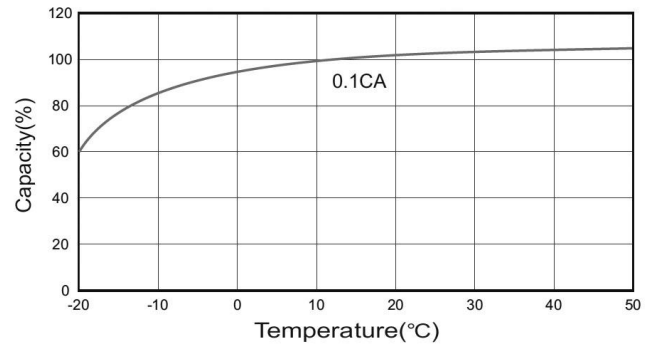

(Note) All above information shall be changed without prior notice, Shimastu reserves the right to explain and update the latest information.